

Bampton Flood Response Plan



Environment Agency: Contact Information

Incident Hotline (to report flood incidents) 0800 80 70 60 (24 hours)

Flood Incident Duty Officer 0800 678 1247

Floodline (to get current flood warning information) 0345 988 1188 (24 hours)

For **Floodline quickdial** options select IVR options 1-1-1-1 then 311016 for river Bathern or 211036 for Middle Exe

Website www.environment-agency.gov.uk/flood

Contents

[Bampton Flood Response Plan](#)

[Contents](#)

[Introduction](#)

[Purpose and scope of the Plan](#)

[Objectives of the Plan](#)

[Locations at Risk](#)

[Risk Mitigation](#)

[Role of Agencies](#)

[Flood Warnings](#)

[Flood Response Team: Roles and Responsibilities](#)

[Role of Property Owners](#)

[Safety](#)

[Actions Triggered by Flood Alert and Flood Warning](#)

[11.1 Pre-Alert](#)

[11.2 Flood Alert \(Grade 1\)](#)

[11.3 Flood Warning \(Grade 2\)](#)

[11.4 Severe Flood Warning \(Grade 3\)](#)

[11.5 All Clear](#)

Contents (cont)

[ANNEX A COMMUNICATION FLOW](#)

[ANNEX B FLOOD RESPONSE TEAM ACTIONS](#)

[ANNEX C \(a\) FLOOD WARDEN ACTIONS](#)

[ANNEX C \(b\) VOLUNTEER ACTIONS](#)

[ANNEX C \(c\) FLOOD WARDEN VOLUNTEERS CONTACT DETAILS](#)

[ANNEX D EQUIPMENT](#)

[ANNEX E DEVON COMMUNITY RESILIENCE FORUM](#)

[ANNEX F MANOR MILL HOUSE FLOOD DEFENCES](#)

[Gate procedure](#)

[ANNEX G RIVERSIDE GATE](#)

[ANNEX H PROPERTIES AT RISK](#)

[ANNEX I FLOOD RISK MAP](#)

[ANNEX J COMMS PLAN](#)

1. Introduction

1.1 The centre of Bampton around Brook Street is prone to flooding. Very serious flooding occurred in 1963 and 2000 with other less serious flood events occurring in the intervening period. Manor Mill House has been flooded on a number of occasions up to 2017. Other parts of Bampton: Tiverton Road by Scott's, Ashleigh Park, Frog Street and properties in Shillingford have also experienced flooding on occasions.

1.2 Flooding can cause severe damage, disruption and, in some cases, casualties to people and property; for that reason flooding is often categorised as a 'major incident' by the emergency services, who need the support and assistance of communities to safely manage the incident and minimise harm.

1.3 There is no statutory responsibility for communities to plan for, respond to, or recover from such emergencies, however the vulnerability of Bampton and surrounding areas to flooding and the cohesion of its community have caused Bampton Town Council to prepare this Flood Response Plan.

2. Purpose and scope of the Plan

2.1 The purpose of this Flood Response Plan is to increase resilience within Bampton by providing guidance for the successful management of flood incidents that might affect the safety of residents, workers and visitors in Bampton.

2.2 The scope of the plan includes flood incidents mainly in the area of Bampton town centre. However, it also makes reference to flood incidents in areas of Bampton outside the town centre and in Shillingford.

3. Objectives of the Plan

3.1 The overall objective of this plan is that we should respond to a flood incident in a structured manner to ensure that there is adequate voluntary support given to the community and the emergency services.

3.2 Actions will be guided by specific objectives, which are as follows:

- Preserving life and the safety of people, especially those who are vulnerable
- Minimising flood damage to property
- To enable the town to return to “business as usual” as quickly as possible

4. Locations at Risk

4.1 Properties in the area of Mill Head, Manor Mill House, New Buildings, Briton Street, Bridge Terrace and Brook Street are most at risk.

4.2 One or more of the following factors can cause Bampton to flood:

- Heavy downpours in any season the volume of water in the River Bathern can rapidly rise
- The Bathern Bridge in Bampton can act as a pinch point causing water to back up upstream and flood the above areas
- The Shuttern Brook, which also flows into the River Bathern at the bridge, may cause flooding to Frog Street, Silver Street and Brook Street areas
- Excess surface water flows down the Old Tiverton Road, into Briton Street, New Buildings and Mill Head
- Excess surface water flows down Frog Land and into Frog Street
- Excess surface water can cause flooding in Shillingford, especially to the Old Chapel
- Excess surface water from Stoney Path into Ashleigh Park - East End
- Gardens in Shillingford adjacent to the River Bathern flood following heavy downpours

5. Risk Mitigation

- In 2006 the Environment Agency (EA) carried out flood protection works, thereby reducing the risks of flooding.
- The EA records water levels in the Shuttern Brook every 3 months.
- Flood barriers have been installed at Manor Mill House and Riverside Hall. The Riverside Hall Barrier will be in place for the winter from the beginning of October until April. The Manor Mill barrier is closed based on a phone message from the EA.
- The EA can check the open/closed status of the flood barrier at Manor Mill House by telemetry.
- Sluice gates have been installed in Frog Street to shut off the water flowing down the edges of Brook Street
- Sandbags to protect vulnerable properties are available from a Town Council store by the bridge.
- The Flood Warden is responsible for contacting the BTC clerk for arranging payment for additional sand if required.
- The Flood Response Plan and a Flood Response Team have been prepared to assist in the management of a flood incident.
- The Flood Warden and FRT will conduct regular inspections of the River Bathern. They will report any issues to the EA who will also undertake inspections.
- A designated person, authorised by Bampton Town Council, will keep the leat grille to the Shuttern Brook in Frog Street gully clear of debris.
- It is expected that able bodied residents will co-operate with the Flood Warden and FRTs to protect their own homes.
- If evacuation is necessary, rest centres will be established at the Quarryman's Rest PH and the Community Hall. Some residents may prefer to go to local relatives

6. Role of Agencies

6.1 The following agencies have roles in the planning and management phases for flood incidents:

- Environment Agency
- Devon County Council
- Lead Local Flood Authorities (LLFA)
- Mid Devon District Council (MDDC)
- Bampton Town Council
- Cornwall & Devon Police
- Devon & Somerset Fire & Rescue Service
- South West Water
- Electricity, gas and telecommunication companies
- Large industrial companies

- See Annex E for the principal actions of each agency.

6.2 The emergency services have primacy in the management of an incident, the police co-ordinate the activity of the other services and voluntary agencies at the incident. The Flood warden or in their absence coordinator should be prepared to brief the first officer arriving at the scene of an incident. The officer will want to know 'CHALET'S':

- Casualties (numbers, location, injuries etc.)
- Hazards present at the scene
- Access to the scene
- Location (exact location)
- Emergency services required
- Type of incident, e.g. flood
- Safety & risks present at the scene

7. Flood Warnings

7.1 The EA operates a flood warning service in areas at risk of flooding, such as Bampton. Information on this can be found at: <https://flood-warning-information.service.gov.uk/warnings?location=devon>

There are three levels or 'grades' of flood alert:

- **Flood Alert.** Flooding is possible - be prepared.
- **Flood Warning.** Flooding is expected - immediate action is required.
- **Severe Flood Warning.** Severe flooding – danger to life.
- **All Clear.** This means 'Flood Alerts or Warnings are no longer in force for the area'.

8. Flood Response Team: Roles and Responsibilities

8.1 A Flood Response Team (FRT) has been established to co-ordinate the response of Bampton's community to a flood incident. The FRT is comprised of voluntary members of the Bampton community who should:

- reside in Bampton and have good local knowledge.
- provide assurance to the vulnerable in an emergency and give assistance where appropriate and safe to do so.
- communicate with the Bampton community and relevant agencies, e.g. Mid Devon District Council, Environment Agency, emergency services.
- maintain confidentiality where necessary.
- keep this plan up to date.
- keep a 'grab bag' containing the plan, appropriate clothing and equipment.
- always put their own health and safety first and to never take any risks that would put either themselves or other people at risk.

8.2 The role of the FRT is to activate this plan and carry out the actions detailed within it. The FRT will act under the direction of the emergency services when they attend a flood incident.

8.3 The FRT is comprised of a local Flood Warden and Volunteers acting on behalf of the BTC to protect the local Community. The Flood Warden acts as a focal point for the community and other agencies in response to a flood emergency. The roles of the FRT are:

A) Flood Warden

- Sign up for free EA flood warnings via text or email (to request: send email to **dc.flood** and ask for warning for the River Batherm at Bampton Bridge area)
- Carry out routine checks to mitigate flood risk including checking drains are clear and the Manor Mill pump is working
- Keep aware of the current situation
- Contacts flood volunteers and advises on actions to prepare for flooding
- Liaises with BTC the local authority, Environment Agency and other organisations
- Updates the volunteers if the situation changes
- Maintains emergency contacts

B) Flood volunteers

- Act on the advice received from the Flood Warden
- Sign up for free EA flood warnings via text or email (send email to **dc.flood** and ask for warning for the River Batherm at Bampton Bridge area)
- Put flood protection measures in place
- Help and advise vulnerable people and help move them to safety early if required
- Inform the community of the situation and advise them to prepare by moving cars, putting sandbags or flood boards in place etc.

8.4 All personnel should know

- What is my role?
- Where should I go?
- Who must I contact?
- What equipment do I need?

Additionally, personnel should:

- inform the Flood Warden of any absence and appoint a deputy
- keep mobile phones charged & check signal
- take part in any training organised by the Environment Agency or others; especially training concerned with practical skills (eg. operating flood barriers at Manor Mill House and Riverside Hall)
- always put their own health and safety first and to never take any risks that would put either themselves or other people at risk.

9. Role of Property Owners

It is expected that property owners in Bampton, Shillingford and any other 'at risk' locations within Bampton Town Council's area will:

- be aware of any risk of flooding to their properties.
- Sign up for free EA flood warnings via text or email (send email to **dc.flood** and ask for warning for the River Bathern at Bampton Bridge area).
- in advance of any flooding incidents, take the necessary precautions (eg. installing flood boards, obtaining sandbags or alternative items, obtaining airbrick covers).
- in the event of flooding move to a safe area if life at risk.
- prevent water from entering property if possible.
- switch off electricity and gas supplies at mains.
- move valuable possessions above areas liable to be flooded.

10. Safety

10.1 Members of the FRT and Volunteers must 'think safety' at all times and not expose themselves or others to unnecessary risks.

Particular note should be taken to not walk-through fast-moving flood waters as water only 15cm (6 inches) can knock you off your feet. After contact with flood water you should toughly wash your hands to avoid contracting Weils and other water borne diseases.

Assistance may be summoned at any time during an incident by one long blast of the whistle issued to FRT members.

11. Actions Triggered by Flood Alert and Flood Warning

11.1 Pre-Alert

When local knowledge indicates that flooding may occur, e.g. during heavy or prolonged rainfall, but before an alert is received, the following actions will be taken:

Flood Warden:

- Know the Flood Incident Duty officer's number
- Assess the risk of flood from visual observation
- Contact the Flood Incident Duty officer if necessary
- Inform the Flood Wardens and check availability of the FRT
- Inform MDDC and request help if drains are blocked
- Check the store door is open and equipment including sandbags are available
- Log actions

11.2 Flood Alert (Grade 1)

Upon receipt of a Grade 1 alert, the following actions will be taken:

Flood Warden:

- Monitor river level and weather forecast
- Check availability of the Volunteers
- Check with the Flood Incident Duty officer
- Warden Richard Brooker or deputy to install Riverside Hall flood barrier
- Warden Richard Brooker to confirm that the Manor Mill flood Barrier is closed

Volunteers:

- Monitor river level and points specifically designated to each
- Know the Flood Incident Duty officer's number
- Co-coordinators Chris Pestaille and Aidan Hanby to check Riverside Hall flood barrier is in place
- Ensure Manor Mill gates shut/pump working

11.3 Flood Warning (Grade 2)

Upon receipt of a Grade 2 alert, the following actions will be taken:

Flood Warden:

- Continue to monitor river level and weather forecast
- Be available to receive Grade 3 alert via two specified landlines and via SMS to mobiles
- Receive updates of actions completed / outstanding from the Wardens and Volunteers
- Inform the Quarryman's Rest PH
- Liaise with Cost-cutter or Spar shop to have food and drink available for Community Hall
- Have available the keys to the Community Hall
- Liaise with principal agencies (see Annex E)

Volunteers:

- Continue to monitor river level and weather forecast
- Be available to receive Grade 3 alert via the Flood Warden
- Alert vulnerable, designated properties including those which already have their own supply of sandbags
- Designated volunteer to prepare to open the Community Hall
- If requested, Signage Volunteer to place warning signs at: Exeter Inn, Scott's and Luke Street
- Try to identify owners of cars in Riverside Car Park and advise removal (do not remove cars – this is a role for police / fire service)
- Check use / occupancy of Riverside Hall and consider evacuation
- Report status of actions to the Flood Warden

11.4 Severe Flood Warning (Grade 3)

Upon receipt of a Grade 3 alert or observed river levels are overtopping or nearly overtopping defenses, the following actions will be taken:

Flood Warden:

- Liaise with BTC Lead and Emergency Services
- Decide on action needed.
- Direct Volunteers to assist in evacuating vulnerable people to the Community Hall, Quarryman's Rest PH or to a local relative, ensuring necessary medication is carried. Call local GP if necessary.
- Note that volunteers do not have the powers to force the public to vacate their homes, they can only advise and give options available
- Keep a record of those members of the public who may be in danger and have not evacuated
- Receive updates of actions completed / outstanding from the volunteers
- Liaise with principal agencies (see Annex E) and provide a list of people that have not evacuated and may be in danger

Volunteers:

- Designated volunteer to open Community Hall and contact
- suitable volunteers to provide refreshments
- Designated volunteers to contact the Quarryman's Rest PH to
- provide warmth and refreshments
- If evacuating as above, ensure necessary medication is also carried
- Report status of actions to the Flood Warden
- If instructed by the Flood Warden, assist vulnerable people to
- Community Hall or Quarryman's Rest PH or other agreed venue.
- If evacuating as above, ensure necessary medication is also carried
- Report status of actions to the Flood Warden

11.5 All Clear

Flood Warden:

- Co-ordinator makes decision to stand down
- Decide if any cleanup is required and co-ordinate the work with the volunteers
- Communicate decision to Volunteers
- Arrange debriefing and assessment of performance

Volunteers:

- If appropriate assist vulnerable people back home.
- Close Community Hall.
- Report to the Flood Warden that tasks are completed

ANNEX A COMMUNICATION FLOW

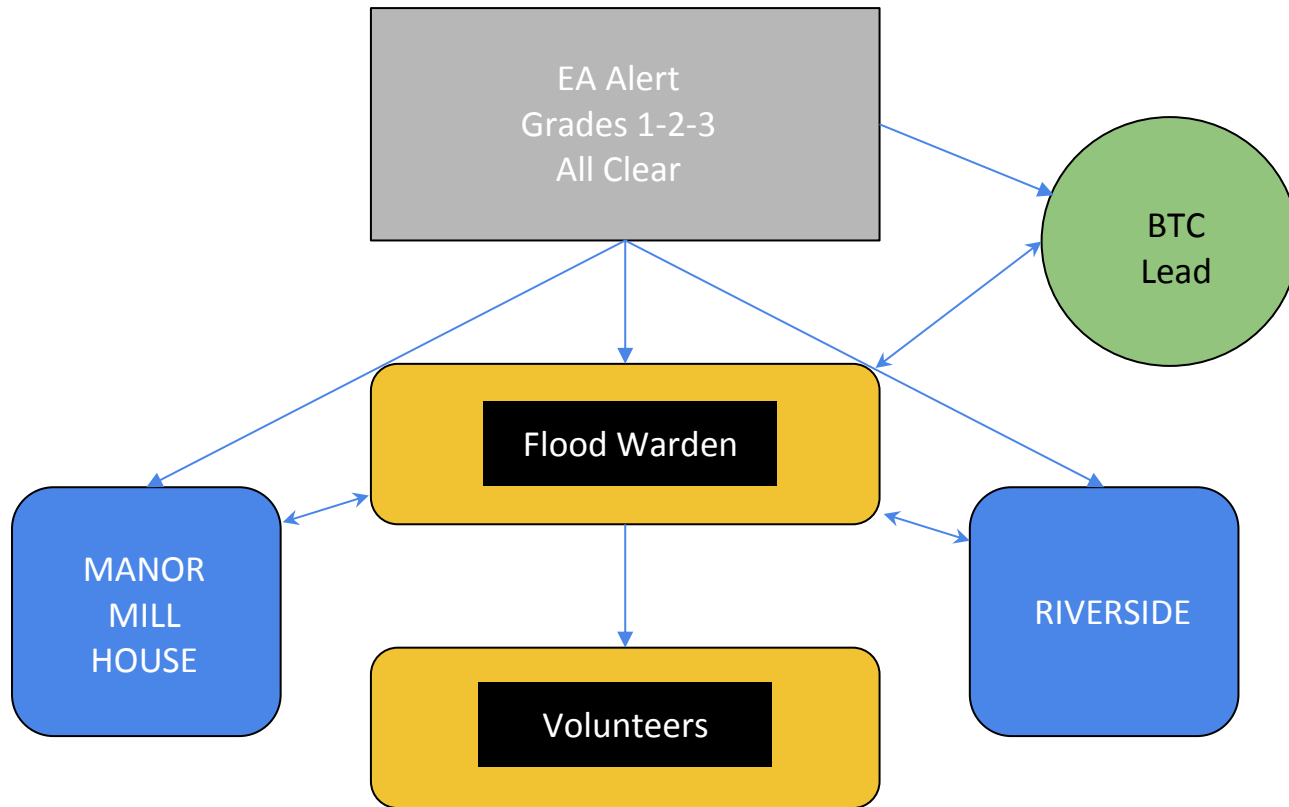

ANNEX B FLOOD RESPONSE TEAM ACTIONS

Flood Response Team: Actions



Pre-Alert



1. Know the Flood Incident Duty officer's number
2. Visual Risk Assessment.
3. Inform Wardens & check FRT availability.
4. Inform MDDC and request help if drains are blocked.
5. Check the store door is open and equipment available.
6. Monitor river level & weather forecast.

Grade 1



1. Confirm status with EA Duty Officer
2. Check availability of Volunteers
3. Flood Warden check installation of flood barriers to Manor Mill and Riverside.
4. Flood Warden liaise with Quarryman's Rest PH.
5. Flood Warden liaise about keys availability to Community Hall
6. Monitor river level and weather forecast.

Grade 2



1. Alert designated vulnerable properties (including those with their own sandbags).
2. Distribute / place sandbags for designated vulnerable people.
3. Check Riverside Hall and consider evacuation.
4. Co-ordinators communicate with volunteers and to prepare to open Community Hall.
5. Flood Warden to place warning signs at Exeter Inn, Scotts and Luke Street.
7. Identify sources of equipment

Grade 3



1. Volunteer open Community Hall and contact suitable volunteers to provide refreshments and Quarryman's Rest PH
2. Consider evacuating vulnerable people (including medication) to Community Hall or Quarryman's Rest PH.
3. Update Flood Warden of actions completed / outstanding.

What is my role?
 Where should I go?
 Who must I contact?
 What equipment do I need?

N.B. All personnel should know:
 > All personnel to inform the Flood Warden of absence and appoint a deputy

Key: FRT:
 EA: Environment Agency
 MDDC: Mid Devon District Council
 PH: Public House

ANNEX C (a) FLOOD WARDEN ACTIONS

Flood Warden Actions



Pre-Alert

Grade 1

Grade 2

Grade 3

1. Know the Flood Incident Duty officer's number
2. Risk Assessment.
3. Monitor river level & weather forecast.
4. Check store door is open.

1. Monitor river level and weather forecast.
2. Risk Assessment.
3. Check flood barriers are in place.
4. Confirm with EA Duty Officer.
5. Check availability of the FRT Volunteers.
6. Inform MDDC and request help if drains are blocked.
7. Check need for barriers in Ashley Park.
8. Liaise with Quarryman's PH.

1. Continue to monitor river level and weather forecast.
2. Be available to receive Grade 3 alert via landlines and mobiles.
3. Receive updates of actions completed / outstanding from FRT.
4. Check Community Hall ready to open.

1. Assess risks and decide on action.
2. Consider evacuating vulnerable people to Community Hall or Quarryman's Rest PH.
3. If so, direct Volunteers to assist (ensure medication is also carried).
4. Receive updates of actions completed / outstanding from FRT.

N.B.
 All personnel should know:

- What is my role?
- Where should I go?
- Who must I contact?
- What equipment do I need?

All personnel to inform Flood Warden of absence and appoint deputy.

ANNEX C (b) VOLUNTEER ACTIONS

Volunteer Actions



Pre-Alert

1. Be prepared:
 - Know your role
 - Ensure equipment available
 - Ensure mobiles charged

1. N.B. All personnel should know:
 - What is my role?
 - Where should I go?
 - Who must I contact?
 - What equipment do I need?

All personnel to inform Flood Warden of absence and appoint deputy

Grade 1

1. Monitor river level and weather forecast.
2. Know the Flood Incident Duty officer's number
3. Report on specific areas responsible.
4. Install flood barriers Ashley Park if needed.
5. Distribute sandbags if required.
6. Await further information and instructions.

Grade 2

1. Continue to monitor river level and weather forecast.
2. Alert vulnerable, designated properties (including those with own sandbags).
3. Distribute sandbags if required.
4. Check use of Riverside Hall and consider evacuation.
5. Advise removal of cars from Riverside Car Park to Station Road Car Park (do not remove cars – police / fire service role).
6. Place warning signs - Exeter Inn, Scott's, Luke Street (If requested).
7. Prepare to open Community Hal.l

Grade 3

1. Nominated Volunteer open Community Hall & contact suitable volunteers to provide refreshments.
2. Nominated Volunteer Contact the Quarryman's Rest PH to provide warmth and refreshments.
3. Assists with any evacuation of vulnerable people. If evacuating people, ensure necessary medication is carried.
4. Report status of actions to the Flood Warden.

ANNEX C (c) FLOOD WARDEN AND VOLUNTEERS CONTACT DETAILS

THIS WILL BE UPDATED SUBJECT TO GDPR REQUIREMENTS

Flood Warden: Richard Brooker Home tel. 01398-331876 Mobile 07754-522357

Volunteer: Aidan Hanby Mobile 07792-221906

Volunteer: Chris Pestaille Mobile 07793-288314

ANNEX D EQUIPMENT

1. The following equipment is stored in the PUMP HOUSE

- 1 x large four wheeled Trolley
- 2 x Builder's buckets
- 2 x Long handle shovels
- 1 x Long handle pointed shovel
- 1 x Long Handle drain spade
- 2 x Flood warning road signs

Keys to the Pump House are held by the Flood Warden

2. The following is stored in the RIVERSIDE – Old Lock Up Store

- Filled sandbags
- Spare sandbags
- 1 x spade
- 5 x sets of drain rods
- 'Flood Warden' fluorescent tabards

The above should be checked annually by the Coordinators.

3. Flood Response Team Members are advised to have available:

- A Torch and whistle
- Protective Gloves
- Personal mobile phone

Fluorescent Tabard will be issued as required.

Bampton Flood Response Plan Updated by Councillor Nick Bull and Flood Warden Richard Brooker 6 July 2021

ANNEX E DEVON COMMUNITY RESILIENCE FORUM

- Who does what during emergencies?
- This lists the principal actions of each organisation
- It may not always be possible for all actions to be carried out during an incident
- Responding organisations have limited resources so may not be able to provide assistance in all circumstances. In such cases, property owners and occupiers need to be aware that they should make their own arrangements to protect themselves and their property

Organisation	Principle activities during emergencies
All agencies	<ul style="list-style-type: none"> • To save life • To protect property • To protect people (public and personnel) • To contain the incident • To safeguard the environment • To facilitate criminal investigation • To inform the public • To restore essential services
Environment Agency	<ul style="list-style-type: none"> • Issues flood warnings • Receives and records details of flooding incidents; this information helps to predict future flood risk • Monitors the situation and advises other organisations; • Responds to flooding, or the threat of flooding, caused by “main rivers” and the sea (tidal or coastal flooding). Environment Agency inspects and clears debris from the trash screens on Higher Brixham Watercourse (which is designated as a main river) • Works with partners, including the local authorities, on other types of flooding, such as non-main river, groundwater and surface water. • Works with other emergency services, such as the police, fire and ambulance services, to respond to flooding • Responds to pollution incidents; • Advises on waste disposal issues.
Local Authorities (Emergency Preparedness)	<ul style="list-style-type: none"> • Risk assessment (Community Risk Register) • Put in place emergency plans. • Create business continuity plans. • Warn, inform and advise the public in the event of an emergency. • Share information with other local responders to enhance co-ordination. • Co-operate with other local responders to enhance coordination and efficiency. • Provide advice and assistance to businesses and voluntary organisations about business continuity management.

Organisation	Principle activities during emergencies
	<ul style="list-style-type: none"> • Identification of the dead • Collation and dissemination of casualty information • Co-ordination of the media response • Application of counter measures to protect the public e.g. will coordinate evacuation if there is a danger to the public, but does not have powers to enforce evacuation • Restoration of normality
South Western Ambulance Service	<ul style="list-style-type: none"> • Save life • Provide treatment, stabilisation and care at the scene
Water Company (South West Water)	<ul style="list-style-type: none"> • Clears blockages in public sewers • May take action to protect property from flooding by water from the public water mains or discharges from the public sewerage systems. • Assess and manage risk of service failure
Electricity (Western Power Distribution)	<ul style="list-style-type: none"> • Attends to emergencies relating to their service at properties where life is at risk e.g. as a result of flooding • attends to flooding emergencies at their own serviced installations • assess and manage risk of service failure
Gas Company	<ul style="list-style-type: none"> • attends to emergencies relating to their service at properties where life is at risk as a result of flooding; • attends to flooding emergencies at their own serviced installations • assess and manage risk of service failure
Maritime & Coastguard Agency	<p>HM Coastguard is the emergency response branch of the Maritime and Coastguard Agency (MCA). The MCA is an executive agency within the Department of Transport (DfT) and has the lead role for dealing with incidents at sea and some inland waters.</p> <p>HM Coastguard is responsible for:</p> <ul style="list-style-type: none"> • Minimising loss of life amongst seafarers and coastal users • Responding to maritime emergencies 24 hours a day • Developing, promoting and enforcing high standards of maritime safety and pollution prevention for ships • Minimising the impact of pollution on UK interests • Responding to non maritime incidents such as floods, searches or assisting in evacuating areas

ANNEX F MANOR MILL HOUSE FLOOD DEFENCES

Gate procedure

1. Using a broom, ensure the threshold of the gate is clear of chippings.
2. Undo the gate taking care to fold back the UV hinged metal covers to the vertical butyl-rubber seals at either end of the gate, pull hard and close it.
3. Engage the closing hook onto a threaded bar in the slot on the side frame of the gate and using the ratchet spanner (from the adjacent cupboard) **securely tighten** the gate onto the rubber seals.
4. Replace the spanner and broom.
5. Telemetry at the gate will **automatically inform the Environment Agency** that the gate is closed and secure.

Additional Manual Pump procedure to drain the leat pool (Honda WB20XT)

1. Identify the pump. Remove protective covers. Check the petrol level in the petrol tank.
2. Nearby should be a **green**, ridged pipe and a smooth **blue** pipe. Ensure the coupling of the pipework is secure.
3. Position the pipework with the green pipe towards the lead. Attach the green pipe to the **lower** side of the pump. Attach the blue pipe to the **top** side of the pump.
4. Throw the **blue exit pipe** over the wall and allow the **yellow** filter on the **green ridged pipe** in the leat to be submerged.
5. Remove the black-threaded plug on top of the pump body and fill the pump with water to “prime” the device (Keep a filled watering can for this purpose).
6. Turn on the **RED** ignition switch on the side of the unit. Make sure the **BLACK** petrol switch is at the RHS ‘on’ position.
7. Move the **GREY** “choke” lever fully to the left.
8. Now active the long “Hare and Tortoise” throttle lever. Start on “Hare” then adjust back towards “tortoise”.
9. Sharply pull the black-handled rope cord which lies adjacent to the air vent housing.
10. As soon as the engine starts move the **GREY** choke gradually to the OFF position.
11. Encourage the blue pipe to inflate by squeezing and/or increasing the engine speed with the choke lever.
12. Adjust the speed with the **GREY** “Hare and Tortoise” throttle lever. (With a full tank the pump should work for 2 hours at full speed or 4 hours at three quarter speed pumping 600 litres per minute).

WARNING - Standard unleaded petrol must be used in this 4 stroke engine. It will not run properly if petrol/oil (2 stroke) mixture is used.

ANNEX G RIVERSIDE GATE

ANNEX G

Flood Control Slot-In - Instructions for use

Read all instructions before fitting.

Installation Examples

Surface Mount

Diagram 1.

Recess Mount

Diagram

2.

Using your System

Beams

The first aluminium beam place - rubbers at the bottom If supplied with an extra insert this beam first. Where system with the handles to the beam firmly to the ground

Slide each aluminium beam seals at the bottom.

Tip : treating the channels' seals with a fine application of silicone spray will allow the beams to slide easily into position. (Please use Silicone Spray ONLY).

Back Braces / Compression Bars

Any braces or bars supplied with the system can now be fixed by removing the stainless steel blanking bolts from the ground fixing holes. (Do not use the blanking bolts to secure the brace to the ground)

Screw any braces or compression firmly to the ground using all fixings & washers supplied.

Clamping Mechanism

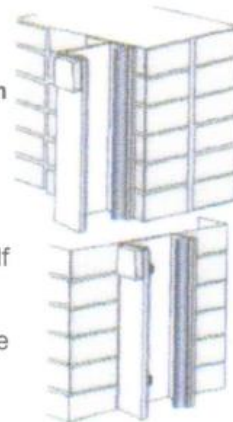

should be slid into one beam has been all-terrain seal, then possible, erect the 'wet' side Push the (Diag.3).

firmly into place, keeping the rubber

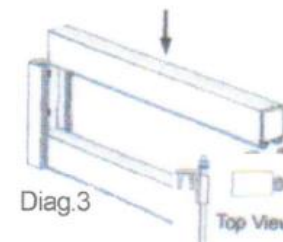
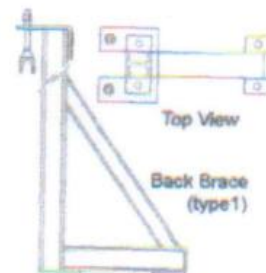
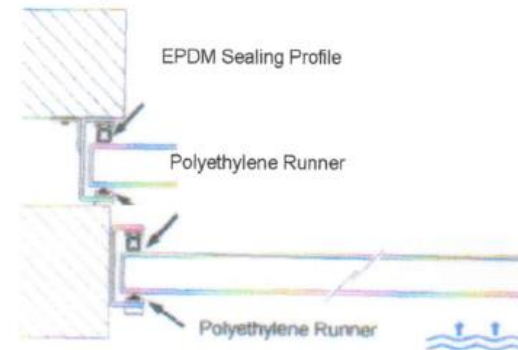

Back Brace (type 2) Diag. 4

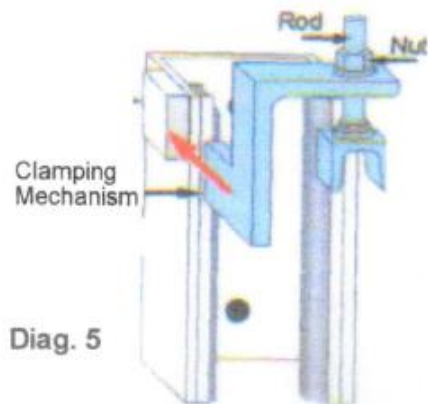

Diag. 5

Insert the clamping mechanisms as far into their holding boxes as possible. (Diag. 4)

Using the spanner provided, loosen the nut on the clamping rod as far as possible (Diag. 5).

Screw the clamping rod down tightly with the hexagonal key. (Diag. 6).

Check for a good even seal along the entire length of the ground surface. Tighten further if necessary.

Screw the nut and washer down tightly locking the clamp into place. (Diag. 7).

U Diag. 6

J Diag. 7

Diag.8

Maintenance

Under normal circumstances the barriers will not require any maintenance, however the following instructions will help to extend the life span of the system

- Flood waters are often contaminated & it is recommended that barriers & channels are rinsed down with a very mild disinfectant before returning them to storage
- If the unit is used in a salt water environment, the barrier and channels **should be hosed down with fresh water before returning them to storage**
- After use, the two seats on the base of each barrier section should be lightly dusted with talcum powder before being returned to storage.
- Apply light machine oil (eg 3 in 1) occasionally to the thread of the clamping mechanism rod.
- The soft EPDM seals in the support channels should periodically be treated with a silicone spray to make insertion of the barriers easier.
- **When the system is not in use, DO NOT store the aluminium beams on the two base seals. (Diag 8).**

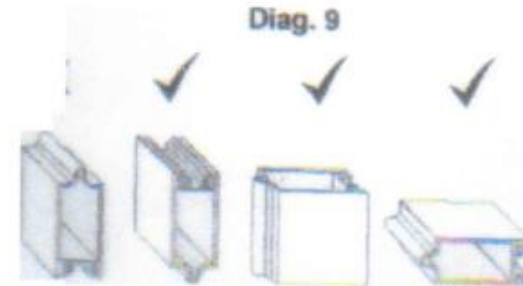

For Assistance, Contact: Flood Control Ltd, Torrington House, New Bridge, Gunnislake, Cornwall PL18 9LH Flood Control Customer Services: 01822 832385 Emergency Duty Engineer: 07813842498

ANNEX H PROPERTIES AT RISK

Homes at Flood Risk from the R. Batherm / Shuttern Brook

Red = Co-ordinator

Blue = MAY NEED HELP

Bridge Terrace	1	2	5	6	7
----------------	---	---	---	---	---

Magnolia Villas, Briton St	1, Old Malt Cottage, Old Malt House
----------------------------	-------------------------------------

Millhead	Manor Mill
	Oakdene

New Buildings	1	2	3	4	5
---------------	---	---	---	---	---

New Buildings (Millhead)	6	7	8	9	10	11	12
--------------------------	---	---	---	---	----	----	----

Brook St (odd nos.)	47	45	2	1 (National Tce),	Court Grove
---------------------	----	----	---	-------------------	-------------

	39	37	35A	35	33 (29 27 25)	23	21
--	----	----	-----	----	---------------	----	----

	19	17	15	13	11	9	7	5	3	1
--	----	----	----	----	----	---	---	---	---	---

Brook St (even nos.)	Overbrook	54	52	50	48	46A	46	44	42
----------------------	-----------	----	----	----	----	-----	----	----	----

	40	38	36	34	32	30	28	26	24	22	20
--	----	----	----	----	----	----	----	----	----	----	----

	18	16	14	12A, 12B	12C	10	8	6	4	2
--	----	----	----	----------	-----	----	---	---	---	---

Silver St	1	1A	2	2A	3	4	4A	5	6	7
-----------	---	----	---	----	---	---	----	---	---	---

Old Stones, Moreland, Exeway	
Silver St other	Rear of 14 Fore St
Frog St	Weaver's, The Old House

ANNEX I FLOOD RISK MAP

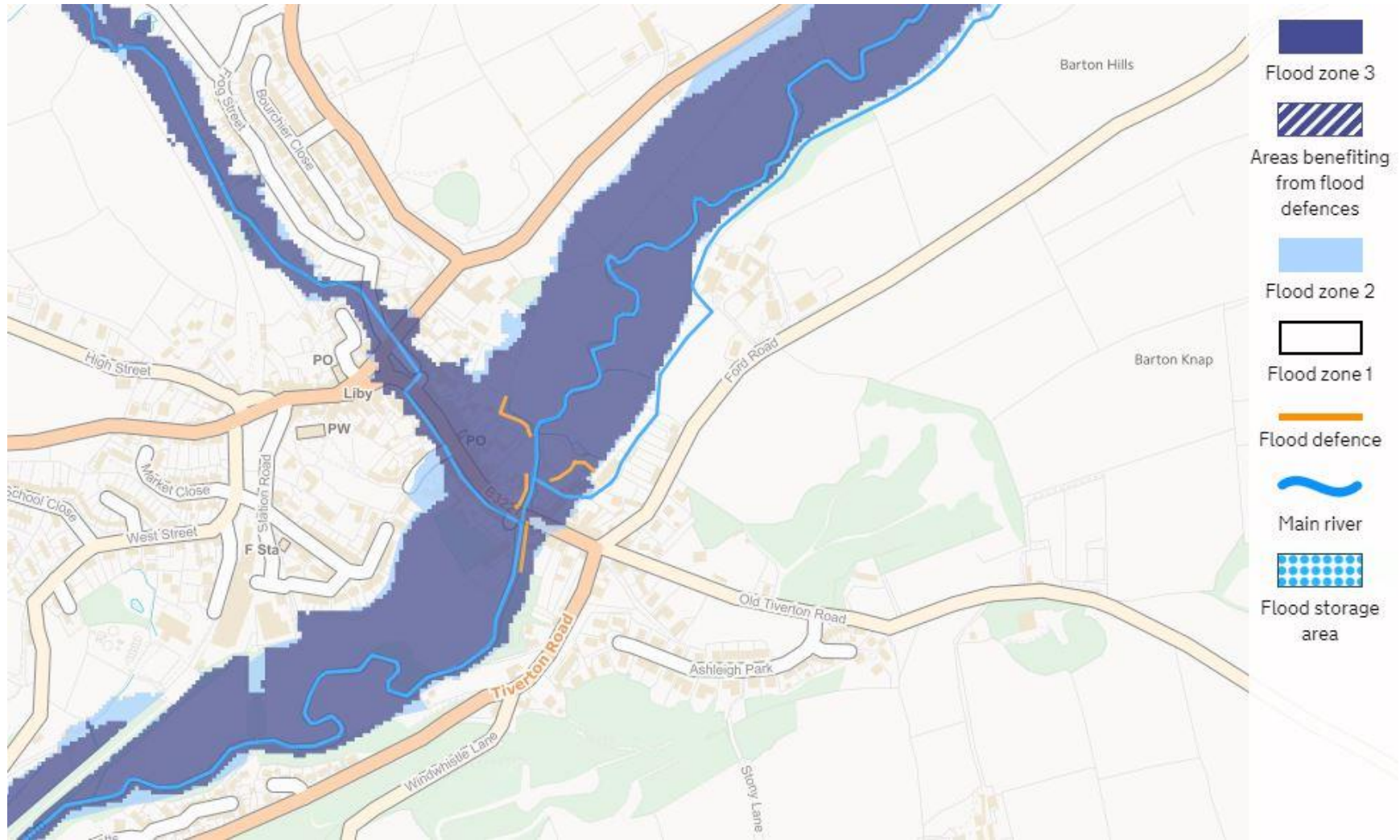

ANNEX J COMMS PLAN

INFORMATION FROM MDDC - EA - FLOOD VOLUNTEERS

